

LAGUNA

QUICK GUIDE





WELCOME ABOARD YOUR LAGUNA

Note

Congratulations on choosing your vehicle: in your Laguna, you will enjoy a unique driving experience!

In order to make your experience as pleasant as possible, we suggest you discover how to get the best out of your Laguna by using this document.

This document does not replace the driver's handbook.

Please read your complete driver's handbook for more detailed information on the equipment mentioned in the reference guide for your Laguna.

Detailed information regarding your vehicle's use, maintenance and warranty, as well as videos and simulators, are all only a click away in the New Laguna e-Guide, available at www.e-guide.renault.com.

Translated from French. Copying or translation, in part or in full, is forbidden unless prior written permission has been obtained from RENAULT, 92100 Billancourt 2009.



Front and engine compartment	3
Passenger side	4
Rear seats	5
Rear	6
Accessing the vehicle	7
RENAULT card, instrument panel	8
Dashboard	9
Multimedia systems	11
Lighting/Wipers	14
Driver's position: seats	15
Driver's position: settings	17
Heating and air conditioning system	18
Electronic parking brake	19
Cruise control/Speed limiter	19
Fuel	20
Gadgets	21

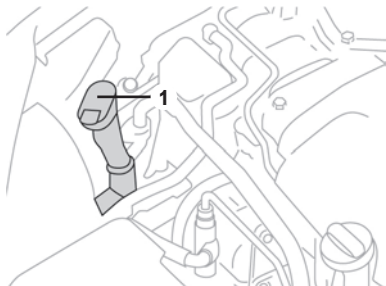

Screen washer fluid level

Add some fluid in the reservoir 1 if necessary.

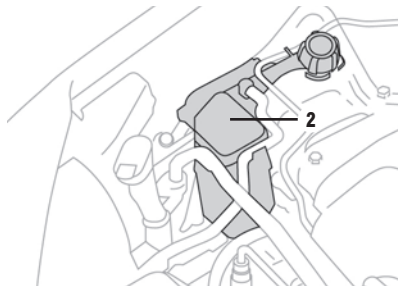

Coolant level

The level indicated on the tank 2 should be between MINI and MAXI.

If it is necessary to top up this level, it is essential to do so when the engine is cold.

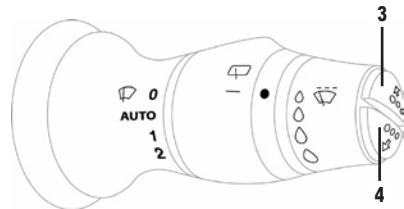

Engine oil level

You can view the oil level on the instrument panel: when the message “test of control system” appears on the instrument panel, press either button 3 or 4. The oil level is displayed on the instrument panel.

You must observe the service intervals and the standards governing the oils tested for your engine. Refer to the Maintenance Service and Warranty document for your vehicle, and to Section 4 of the vehicle handbook for the precautions to take when filling with oil.



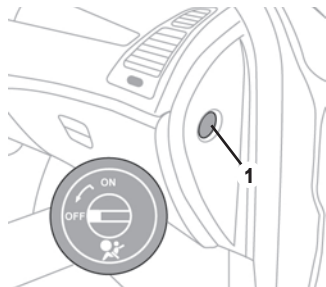

Deactivating the front passenger air bag

If you wish to fit a rear-facing child seat on the front passenger seat, you must deactivate the air bag: with the vehicle stationary, turn switch **1** to OFF.

Indicator light  lights up on the central display on the dashboard.

Reposition the switch immediately to **ON** as soon as you are no longer using the child seat.



Sockets for audio connection

Depending on the version, you have the option to connect your portable audio devices, USB key, and MP3 player to your vehicle. Specially designed sockets are located in the glove box.

Refer to the instructions for the equipment for details of the connections.



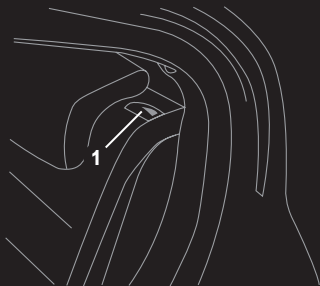

Folding the seatback down

Saloon version: press handle **1** on the side to be folded down.

Estate versions: the vehicle is fitted with a system that allows the seats to lay flat in a single operation. Pull handle **4** on the side to fold down. The luggage net requires certain precautions, refer to the information on "Luggage net" in Section 3 of your driver's handbook.

Ensure that nobody is near to the bench seat when you fold it down.
Remember to remove anything on the rear bench seat.

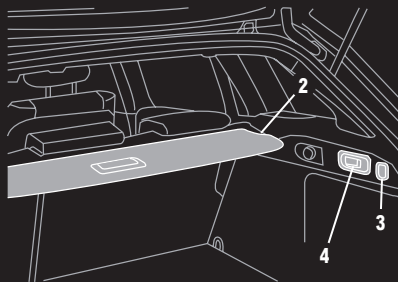

In all cases, to return the seatback to its initial position, check that the seat belts are in the correct position and lift the seatback.

Rear functions of the estate

It offers intelligent storage solutions in the rear luggage space with bag hooks **3**, storage compartments in the side sections of the luggage compartment, an automatically retractable sliding luggage compartment cover **2**, a storage compartment for the luggage compartment cover under the carpet and other innovations to discover in your driver's handbook.

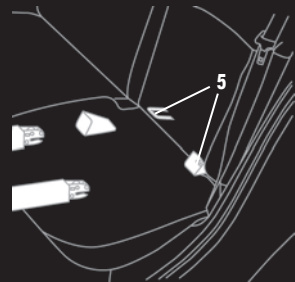

ISOFIX system

Each rear side seat is fitted with the ISOFIX child seat mounting system **5**.

Depending on the type of child seat used, installation requires specific precautions.

Refer to the information on "Child safety" in Section **1** of your driver's handbook for the special features.

Consult your approved dealer to find out about the equipment available for your vehicle.



Parking distance control

On equipped vehicles, the parking distance control measures the distance between the rear and/or the front of the vehicle and any obstacles that are nearby.

When approaching an obstacle during manoeuvres, the beeps become faster and then sound continuously when 25 cm from the obstacle.

The system can be permanently deactivated (refer to the user instructions).

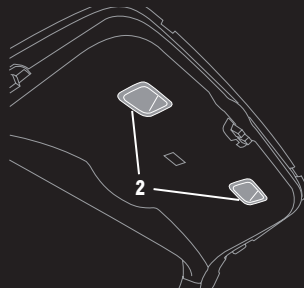

Opening the tailgate

Press button **1** located in the centre of the badge on the tailgate. When the tailgate opens a little, lift it by placing your fingers underneath.

Closing the tailgate

Using one of the handles **2** (depending on the vehicle), lower the tailgate.

It will close under its own weight.

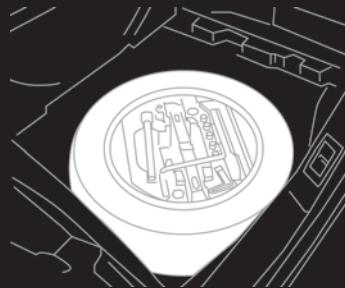

Tyre pressure kit/ emergency spare wheel

Depending on the vehicle, in the event of a puncture, there is either a tyre inflation kit or emergency spare wheel available. To access it, lift the luggage compartment carpet.

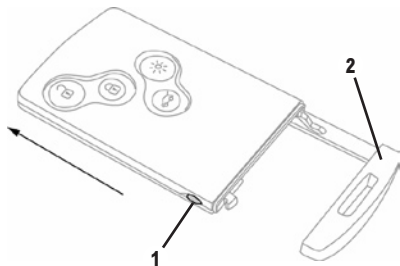

Locking/unlocking the vehicle

The RENAULT card system replaces the traditional key. Locking/unlocking the vehicle is simple: whether from a distance or nearby, a single press is required.

Never leave the RENAULT card in the vehicle

REMOTE CONTROL RENAULT CARD VERSION

Press:



to unlock;



to lock;



to switch the exterior lights on/off remotely (in order to find your vehicle in a car park for example);



to lock/unlock the luggage compartment only.

HANDS-FREE RENAULT CARD VERSION

With the card on your person (you can leave it in your pocket, bag etc.), in addition to the remote control RENAULT card functions, the following are possible:

- automatic unlocking by pulling a door handle;
- automatic locking when leaving the vehicle (a beep sounds) or intentional locking by pressing the button on the driver's door handle.

Note: if required, you can use the manual mode or the key **2**. To release the key, press button **1**.

SPECIAL FEATURES

- The detection zone of the card, necessary for locking and unlocking the vehicle, depends on the surrounding environment or the location of the card;
-  for vehicles equipped with deadlocking, two successive presses on this button stop the vehicle from being opened, even from the inside and, depending on the vehicle, the windows are closed.

NOTE

In all situations:

- Two flashes of the direction indicator lights confirm locking;
- one flash of the direction indicator lights confirms unlocking.

After locking/unlocking the vehicle or the tailgate only using the buttons on the RENAULT card, remote locking and unlocking in hands-free mode are deactivated.

To reactivate the hands-free mode: restart the vehicle.

Starting the engine

With the remote control RENAULT card in reader **2** or the hands-free RENAULT card in the passenger compartment (excluding certain high locations such as the sun visor, etc.) apply the following starting conditions:

MANUAL GEARBOX

With the gear lever in neutral, press button **1**.

AUTOMATIC TRANSMISSION

With the lever in position **P**, press button **1**.

Note: for vehicles fitted with the hands-free RENAULT card, the brake pedal must be depressed to allow the engine to be started.

Stopping the engine

With the vehicle stationary, press button **1**.

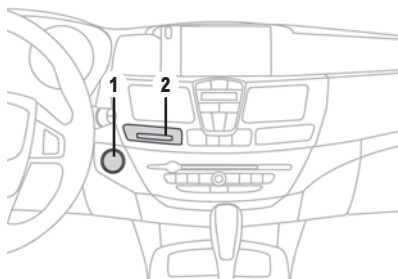

Accessing functions

Once you have gained access to your vehicle, you may use some of its functions (radio, navigation, wipers, etc.).

Depending on the case, these functions will switch off at the latest when the vehicle is locked.

Vehicle settings personalisation menu

Certain functions (parking distance control etc.) can be adjusted from the trip computer and warning system. To access this menu, with the vehicle stopped:

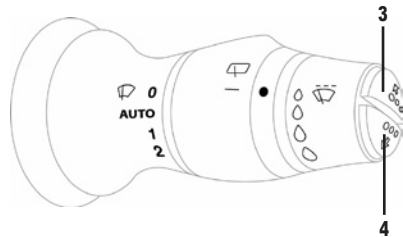

- press button **3** or **4** several times until the message “settings menu: long press” appears,
- hold down button **3** or **4** until the message “settings menu” appears,
- press button **3** or **4** repeatedly until you find the function you wish to modify.

To exit the menu:

- press **3** once or more to select “Back” or “Exit”;
- press and hold **3** to confirm;
- repeat the operation if necessary.



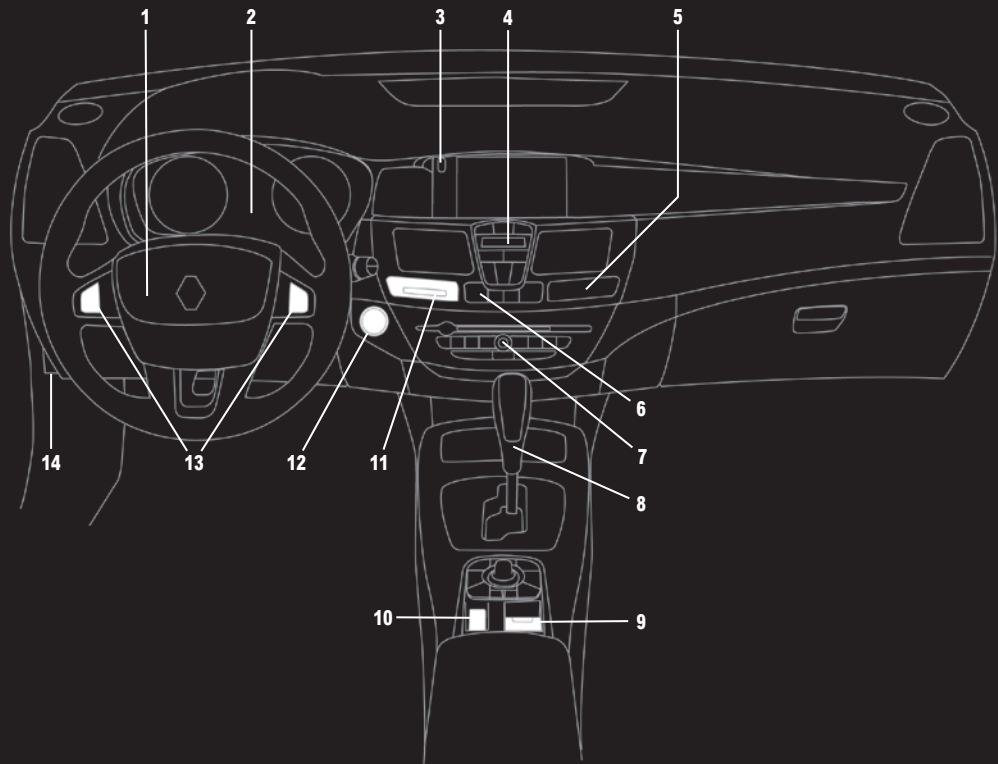



1 Horn and location for driver's air bag.

2 Instrument panel

– Warning lights:

 this warning light requires you to stop immediately, for your own safety, as soon as traffic conditions allow. Stop your engine and do not restart it. Contact an approved Dealer.

 this means you should drive very carefully to an approved Dealer as soon as possible. You risk damaging your vehicle if you keep driving after this warning light has come on.

– Distance before service:

The vehicle is fitted with a system that monitors the condition of the engine oil. This system adapts the distance before service in real time according to the vehicle's conditions of use.

In all cases, an initial message “service due in...” along with the remaining distance notifies you of when the next service will be due. Later, if necessary, the message “service vehicle” requires that the vehicle be serviced as soon as possible.

– Aiding fuel economy:

For vehicles fitted with a manual gearbox, this function indicates the best time to change gear to optimise fuel consumption.



shift up a gear;



shift down a gear.

3 Seat belt reminders:



driver or front passenger seat belt not buckled.

For the rear seat belts, a message on the instrument panel indicates the number of seat belts that are buckled.

4 Heating and ventilation controls.

5 Cup holder.

6 Hazard warning lights.

7 Radio location.

8 Gear lever.

9 Electronic parking brake control.

10 Cruise control/speed limiter on/off main switch.

11 RENAULT card reader.

12 Engine start/stop button.

13 Cruise control/speed limiter controls.

14 Bonnet release control.

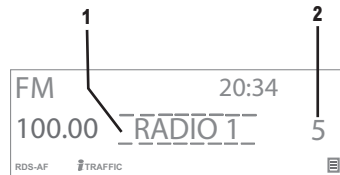
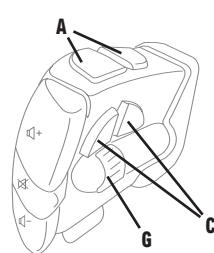
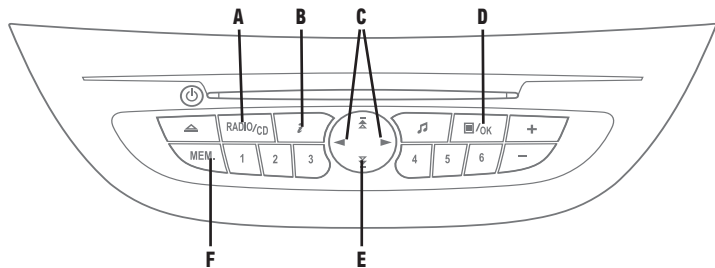

LISTENING TO THE RADIO, A CD (AUDIO AND MP3) OR A PLAYER

Select the desired source by pressing one of the buttons **A** once or more.

If you wish to listen to an AUXILIARY source, connect your portable audio player to the desired socket (refer to the "Passenger side" section).

FM RADIO SOURCE

– To select a radio station from a list in alphabetical order:

Press **C** to move to the station name field **1** then turn **G** or press **E** several times to scroll through the list of radio stations.

– To update the list:

Press **B**, then **E** or turn **G** to select the "Update FM List" field and confirm by pressing **D** or **G**.

– To store a station to one of the buttons numbered 1 to 6:

Select a radio station and press one of the buttons 1 to 6 until a beep sounds.

To recall a stored station, press the corresponding button.

– To store up to 12 FM stations:

Select a radio station, press **F**, then use **E** or turn **G** to select a location from 1 to 12 then confirm by pressing **D** or **G**.

To recall a stored station, move across to the station number **2**, then scroll through the radio stations using **E** or **G**.

To move across the displays **1**, press buttons **C**.

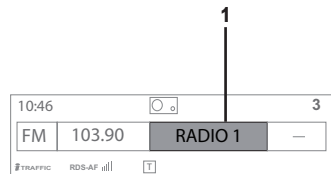
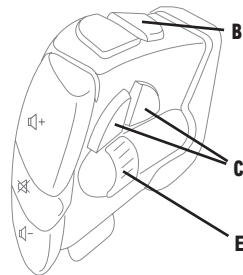
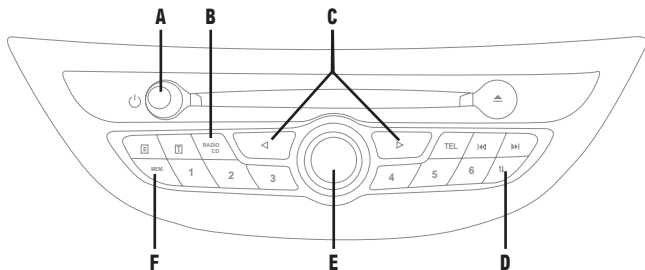

To switch the system on or off, press **A**. Adjust the volume by turning button **A**.

LISTENING TO THE RADIO, A CD OR AN AUDIO PLAYER

Select the desired source by pressing one of the buttons **B** once or repeatedly. If you wish to listen to an AUXILIARY source, connect your audio player to the corresponding socket.

FM RADIO SOURCE

To select a radio station from an alphabetical list, press **C** to go to the station name field, then turn **E** to scroll through the list of radio stations.

TO UPDATE THE LIST:

Press **D**, then turn **E** to select the "Audio settings" field then "Radio functions" and "Update FM list"; confirm by pressing **E**.

TO STORE ONE STATION:

Select a station and press one of the buttons 1 to 6 until a beep sounds. To recall a stored station, press the corresponding button.

To store up to 12 stations, select a station and press **F**, turn **E** to select a location from 1 to 12 then confirm by pressing **E**.

To recall a stored station, move across to the station number, then scroll through the radio stations using **E**.

PAIRING A BLUETOOTH® DEVICE (AUDIO PLAYER, ETC.)

To use your Bluetooth® device, you must ensure the system recognises it (pairing), before it is used for the first time. Once the vehicle is started, your device will then be recognised and automatically connected to the hands-free system.

To move across the displays **1**, press buttons **C**.

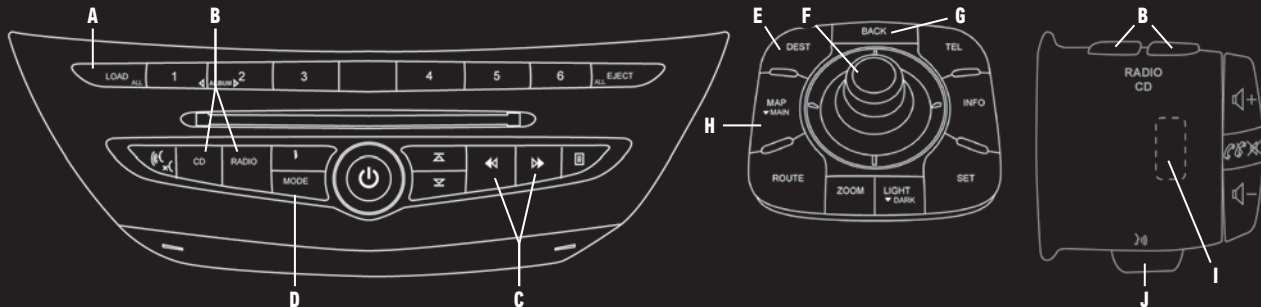

LISTENING TO THE RADIO OR A CD

Choose the source (FM radio or CD) by pressing one of the buttons **B**.

FM RADIO SOURCE

To select a radio station from an alphabetical list, press **D**, choose the "List" mode, then select the name of the radio either using the arrows **C** or by turning control knob **I**.

To store a radio station to one of the buttons numbered 1 to 6:

- select the radio station;
- press on one of the buttons from 1 to 6, until a beep sounds.

To recall a stored radio station, press the corresponding button.

CD SOURCE

Before inserting a CD, press button **A**. You can insert up to 6 CDs.

VOICE RECOGNITION

Button **J**: to operate certain functions using voice control.

STARTING THE NAVIGATION SYSTEM

- Press **E**;
- turn button **F** to select "new address" then confirm by pressing **F**;

- enter the address fields (town and street) using the keypad on the screen. To select and confirm a character, rotate then press button **F**;
- when entry is complete, select "Start" and follow the voice guidance and on-screen directions to your destination.

CANCELLING AN ACTION

Press **G** if you wish to return to the previous menu or erase an entered character.

DISPLAYING THE MAP

Press button **H** to return to the map at any time.

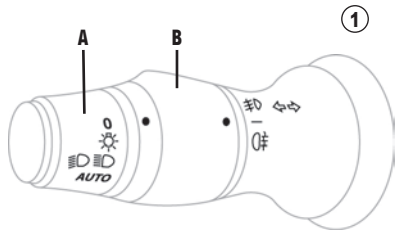

Lighting

On stalk **1**, turn ring **A** to:



switch on the side lights;



switch on the dipped beam headlights;

Flash headlights: pull the stalk towards you;

Main beam headlights: with ring **A** in position



, pull the stalk.

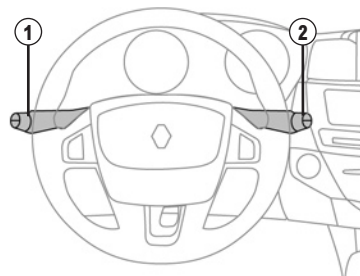

AUTO: activate the automatic headlights (depending on the vehicle).

Turn ring **B**, then release it to:



switch on the front fog lights;



switch on the rear fog light.

To switch them off, repeat the operation.

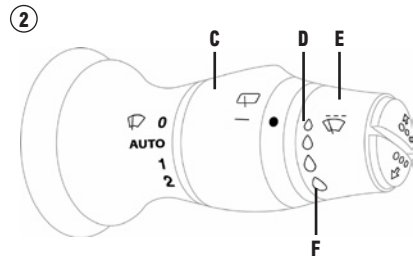

Wiping

Stalk **2** in position:

0: park;

AUTO: intermittent wiping or, depending on the vehicle, automatic wiping

Note: ring **E** can be used to adjust the sensitivity of automatic wiping, from minimum sensitivity (**D**) to maximum sensitivity (**F**).

1: normal wiping speed;

2: fast wiping speed.

Rear screen wiper: to start/stop wiping, turn ring **C** towards you, then release it.

Windscreen washer: pull stalk **2**.

Rear screen washer: push stalk **2**.

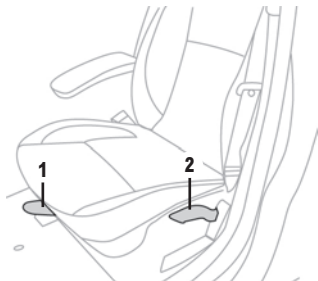

Manual seat adjustment

TO MOVE THE SEAT FORWARDS OR BACKWARDS

Lift handle **1**, slide the seat to the required position and release the handle. Check that it is correctly locked.

TO RAISE OR LOWER THE SEAT

On equipped vehicles, move handle **2** as many times as is required:

- upwards to raise the seat;
- downwards to lower the seat.

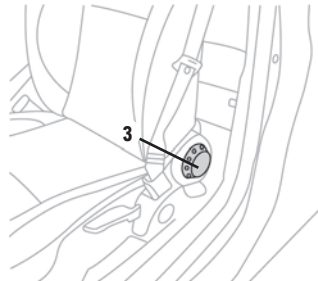

TO TILT THE SEATBACK

Turn control knob **3**.

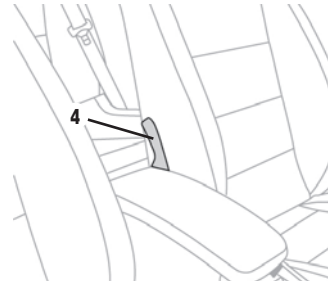

ADJUSTING THE LUMBAR SUPPORT ON THE DRIVER'S SEAT

Lower handle **4** to increase the support and lift it to decrease it.

Carry out these adjustments when the vehicle is stationary.

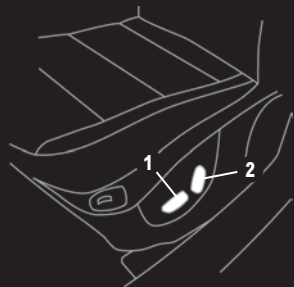

TO RAISE OR LOWER THE FRONT OF THE SEAT BASE

On the driver's side, raise or lower the front of the seat switch **1** until the required height is reached.

TO TILT THE SEATBACK

Move the top of the switch **2** forwards or backwards until the required angle is reached.

Electric seat adjustment

TO MOVE THE SEAT FORWARDS OR BACKWARDS

Move the switch **1** forwards or backwards to the required position.

TO RAISE OR LOWER THE SEAT

Move the switch **1** up or down until the required height is reached.

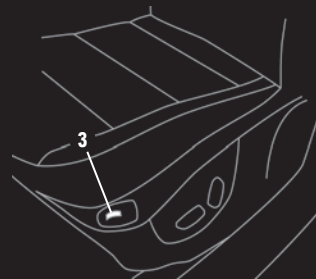

Heated seats

Turn control knob **3** to the position corresponding to the required temperature (1, 2 or 3).

To turn it off, move the control knob back to position 0.

The system maintains the required temperature with a thermostat.

An indicator light on the instrument panel lights up once the front seat heating system is operating.

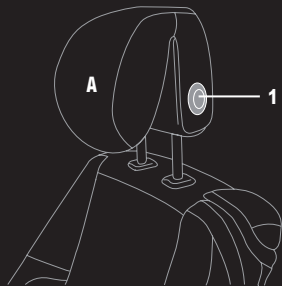

Headrest

RAISING THE HEADREST

Raise the headrest to the required height.

LOWERING THE HEADREST

Press button **1** and lower the headrest to the required height.

TO ADJUST THE ANGLE OF THE HEADREST

Depending on the vehicle, move section **A** towards or away from you to the required position.



Seat belt

ADJUSTING THE HEIGHT

Push control **2** and adjust the belt to the desired height.

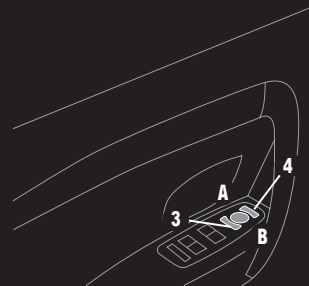

Door mirrors

ADJUSTMENT

Press button **3** to select the rear view mirror to be adjusted.

FOLDING DOOR MIRRORS

Switch **4** in central position: the rear view mirrors will fold back automatically when the vehicle is locked. They will fold out when the ignition is next switched on.

To force the door mirrors to fold back or out, position switch **4** to **B** or **A**. Automatic mode is then deactivated. To reactivate it: position the switch **4** in the central position.

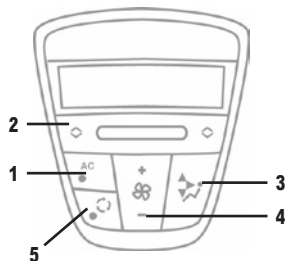

Manual air conditioning

All the controls for the air conditioning system are located between the air vents.

If you want to:

- activate the air conditioning: press switch **1**;
- choose the temperature: move lever **2**;
- modify the distribution of air: scroll through the 6 positions by pressing switch **3**;
- adjust the ventilation speed: press switch **4**;
- activate the air recirculation: press switch **5**.

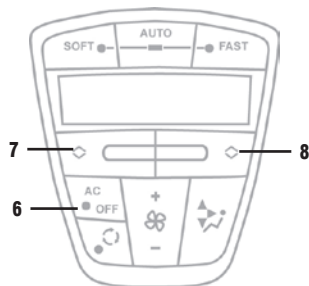

Automatic climate control

To benefit from automatic climate control, choose the right and left-hand temperatures required using levers **7** and **8** and select one of the three automatic programs:

- **AUTO**: mode where the temperature is reached gradually;
- **SOFT**: mode where the temperature is reached slowly;
- **FAST**: mode where the temperature is reached quickly.

Note: pressing one of the other buttons will exit automatic mode according to your requirements.

AIR CONDITIONING

Button **6**:

- authorises the air conditioning (AC OFF indicator light off); in this case, the system decides whether air conditioning is needed.
- prohibits the air conditioning (AC OFF indicator light on); in this case, the air conditioning is deactivated.

AUTOMATIC RECIRCULATION

Your automatic climate control is fitted with a sensor that measures the external air quality. If polluted air is detected, air recirculation will be activated automatically.

Note: the integrated indicator on button **5** only comes on when air recirculation is activated manually.



Electronic parking brake

Depending on the vehicle, the brake is automatically activated when the engine is switched off by pressing the engine start/stop button (unless the engine has stalled).

The parking brake is automatically deactivated: with the engine running and a gear engaged, as soon as the clutch is released (manual gearbox) when accelerating.

The assisted parking brake, like the manual parking brake, also enables:

- manual engagement: lift the switch **1**;
- manual release: with the brake pedal depressed, press switch **1**.



Cruise control/speed limiter

If fitted to the vehicle, activate the cruise control or speed limiter by moving switch **2**:



cruise control;

Note: you can always interrupt the cruise control operation by pressing on either the brake pedal or the clutch.



speed limiter.

Note: you can always exceed the limiter speed by depressing the accelerator pedal fully.

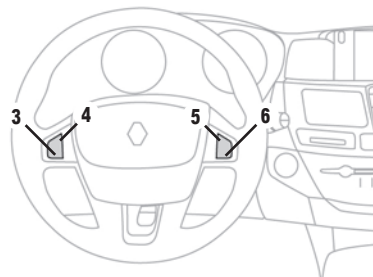

Cruise control/speed limiter controls

- 2** Main "On/Off" switch.
- 3** Programmed speed activation, storage and decrease switch (-).
- 4** Programmed speed activation, storage and increase switch (+).
- 5** Programmed speed activation, storage and recall (R).
- 6** Switching the function off (with stored programmed speed) (O).

Refer to Section 2 of your driver's handbook.

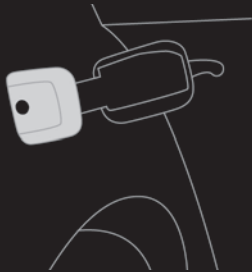

Fuel tank

Your vehicle is fitted with an integrated fuel filler flap.

- Press the left-hand side of the flap to open it, then insert the nozzle.
- When driving, when the low fuel level warning light comes on, fill the tank as soon as possible.
- After the warning light comes on, you have approximately 30 miles (50 km) left, driving at moderate speed.

The fuel tank capacity is **approximately 66 litres.**



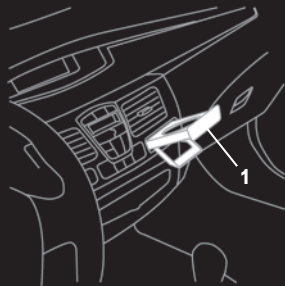

Cup holder

Press **1** to deploy the cup holder. Push it to return it to its housing.

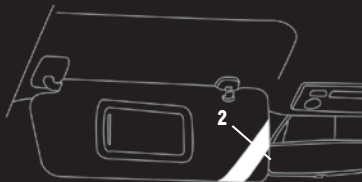

Ticket holder

The driver's sun visor is fitted with a band **2** which holds motorway tolls and this reference guide, etc.

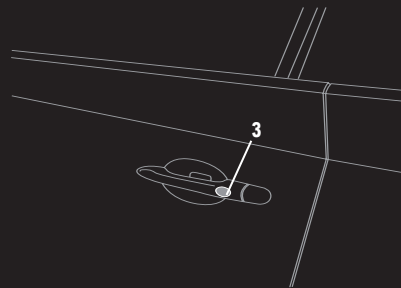

Automatic raising of electric windows

If all of the windows are fitted with the one-touch function, you can close them simultaneously by pressing the locking button on the card or driver's door handle **3** twice.

Important: on equipped vehicles, this will activate deadlocking.

(www.e-guide.renault.com)

RENAULT S.A.S. SOCIÉTÉ PAR ACTIONS SIMPLIFIÉE AU CAPITAL DE 533 941 113 € / 13-15, QUAI LE GALLO
92100 BOULOGNE-BILLANCOURT R.C.S. NANTERRE 780 129 987 — SIRET 780 129 987 03591 / TÉL. : 0810 40 50 60
RP 814-6 – 99 91 014 67R – 03/2009 – Edition anglaise



9 9 9 1 0 1 4 6 7 R

ZT